



CPP
PREMA

arp
Grupa
ARP S.A.

OFERTA produktowa





Centrum Produkcyjne Pneumatyki
„PREMA” Spółka Akcyjna
Ul. Wapiennikowa 90
25-101 Kielce

Informacja o zamówieniach

+48 41 366 95 22
+48 41 366 95 21
sklep@cpp-prema.pl

sklep.cpp-prema.pl

Kontakt – Dział Sprzedaży

Lubelskie, Małopolskie, Podkarpackie
Telefon: 721 380 703
E-mail: handel@cpp-prema.pl

Dolnośląskie, Lubuskie, Opolskie,
Wielkopolskie, Zachodniopomorskie
Telefon: 887 150 083
E-mail: handel@cpp-prema.pl

Kujawsko-Pomorskie, Mazowieckie, Podlaskie,
Pomorskie, Warmińsko-Mazurskie
Telefon: 783 900 117
E-mail: handel@cpp-prema.pl

Łódzkie, Śląskie, Świętokrzyskie
Telefon: 693 991 922
E-mail: handel@cpp-prema.pl



OFFERTA produktowa

Napędy pneumatyczne	4
Akcesoria i mocowania	8
Zawory rozdzielające	10
Przygotowanie powietrza (FRL)	12
Połączenia, złączki, armatura	14
Przewody i węże	18
Zawory funkcyjne	20
Armatura przemysłowa / Elektrozawory membranowe	22
Szybkozłącza i złącza do węży	24
Narzędzia / Pomiar / Bezpieczeństwo	26
Hydraulika siłowa	28
Kompresory i uzdatnianie powietrza	30



NAPĘDY PNEUMATYCZNE

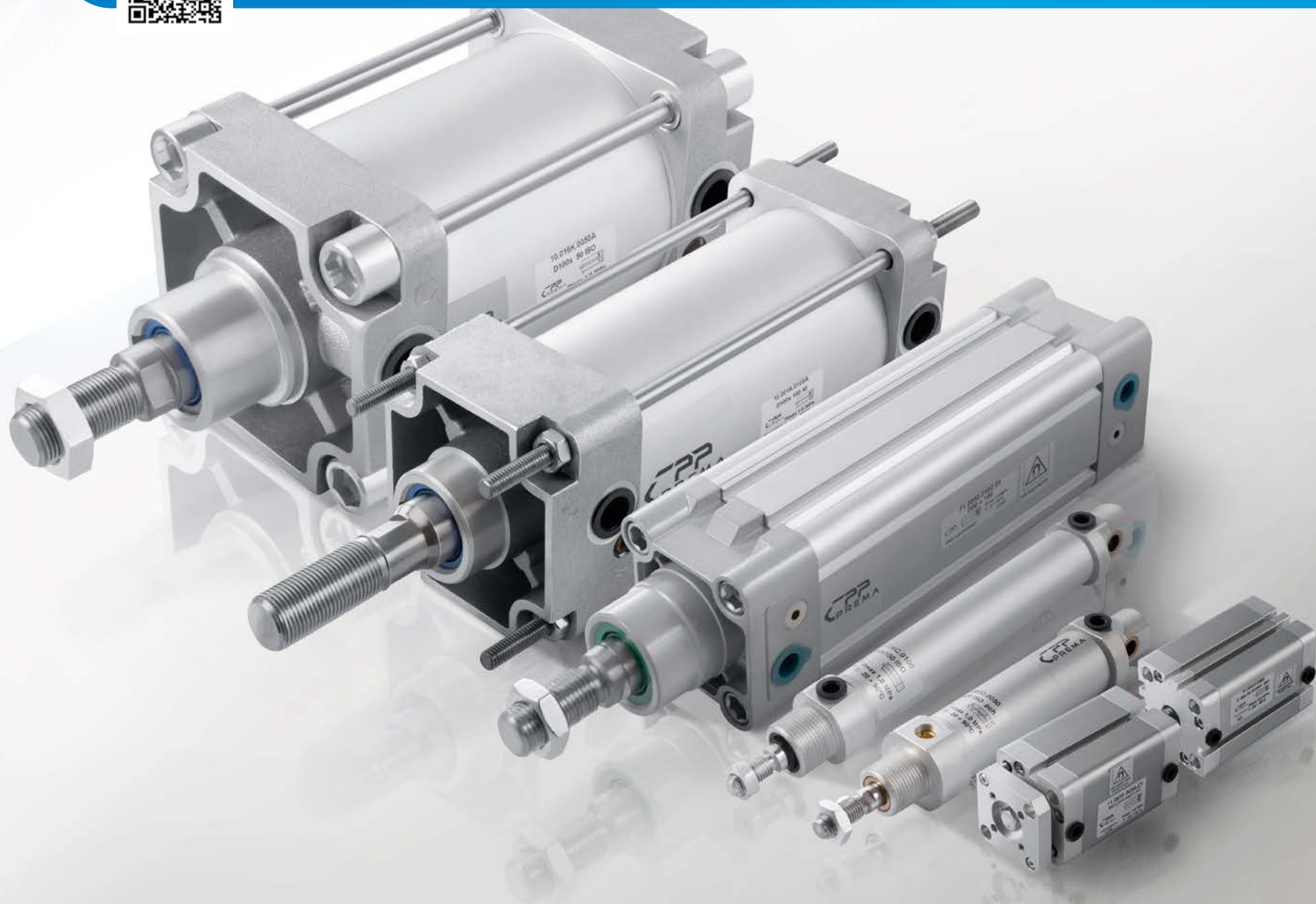

Siłowniki



Minisiłowniki ISO
6432 (D12 – D25)



Okrągłe D32



Okrągłe D32 – D100



Kompaktowe ISO
21287



ISO1552 / ISO6431



Trudne warunki

Siłowniki



Beztłoczkowe



Wahadłowe

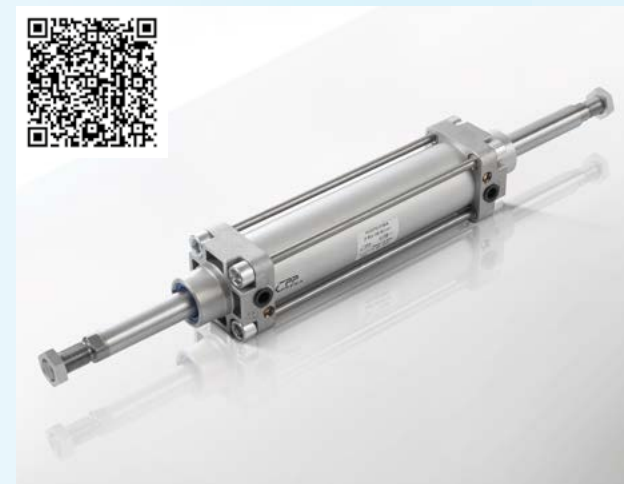

Z dwustronnym
tłoczkem



Tandem



Dociskowe okrągłe



Zestawy naprawcze



Specjalne



Obrotowe jednostronnego działania



Obrotowe dwustronnego działania



CNOMO



Z tuleją kształtową D32 - D100



Z tuleją profilową D32 - D125



Z wydłużonym tłoczyskiem



AKCESORIA I MOCOWANIA



Akcesoria i mocowania do siłowników pneumatycznych



Końcówki tłoczysk



Czujniki i uchwyty



Blokady tłoczysk



Prowadniki



Widelki i ucha



Łączniki kompensacyjne



Łapy i kołnierze

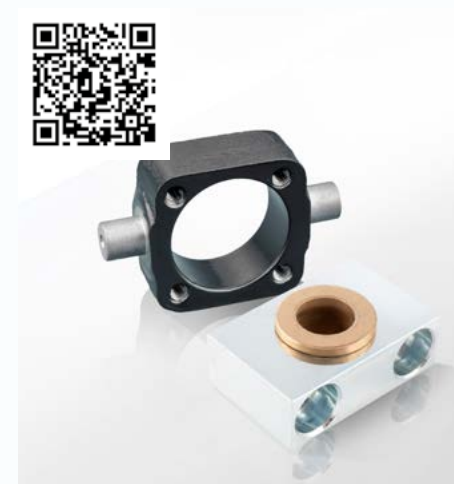

Jarzma i wsporniki



ZAWORY ROZDZIELAJĄCE

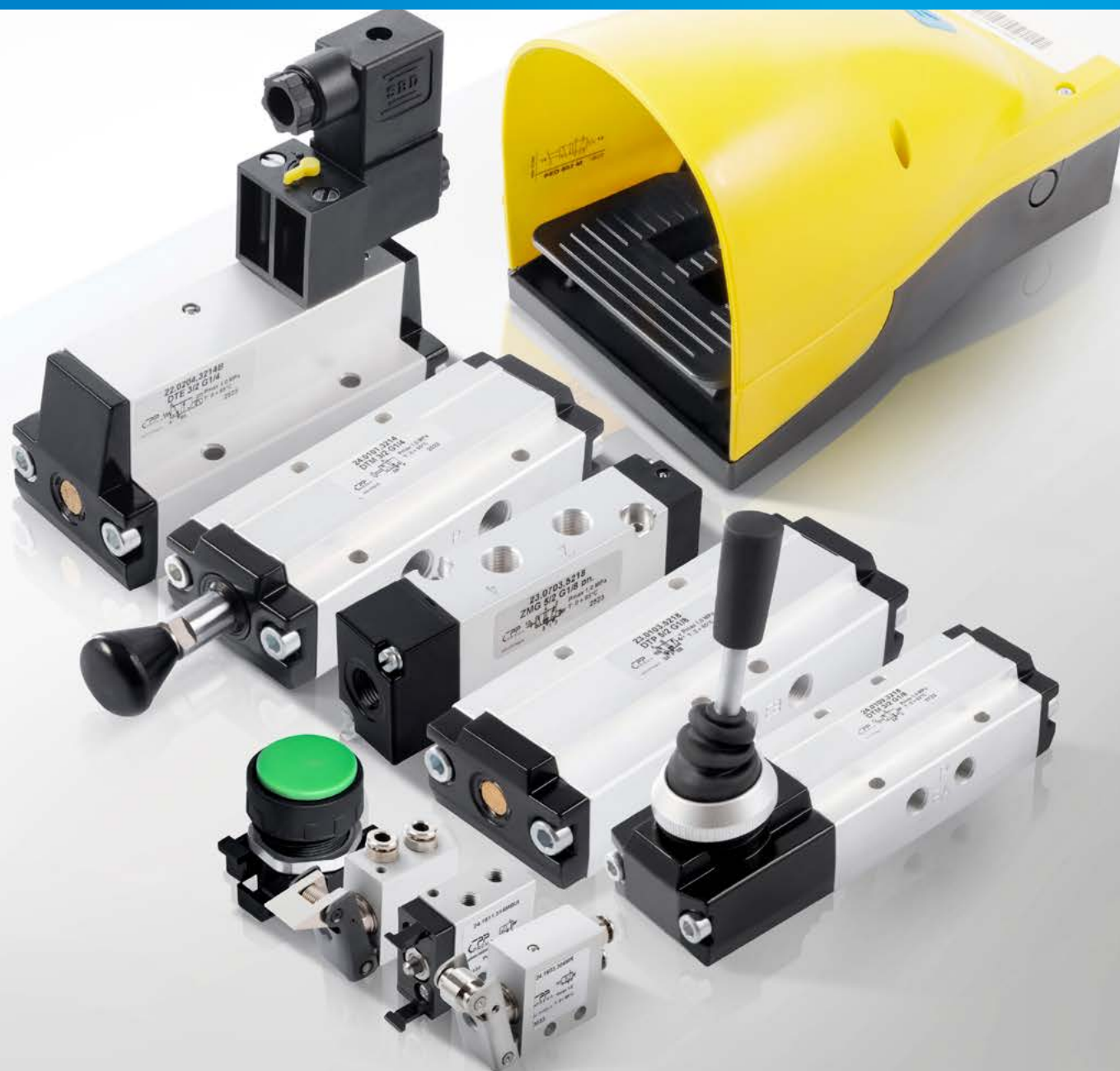

Zawory rozdzielające



Elektrozawory 3/2



Elektrozawory 5/2 - 5/3



Elektrozawory 5/3



NAMUR



ISO



Sterowane
pneumatycznie 3/2



Sterowane
pneumatycznie 5/2 - 5/3



Sterowane
pneumatycznie 3/3



Ręczne /
mechaniczne



Mikrozawory



Nożne



Akcesoria do zaworów
i elektrozaworów



PRZYGOTOWANIE POWIETRZA (FRL)



Przygotowanie sprężonego powietrza



Zespoły FRL



Filtrareduktory



Smarownice
i naolejaczki



Separatory
cyklonowe



Zawory redukcyjne



Filtry



Przełączniki



Zawory SOFT-START



Zawory odcinające



Akcesoria

Łączniki rur i przewodów



Złączki wtykowe z mosiądzu niklowanego



Złączki wtykowe z tworzywa



Złączki wtykowe nierdzewne



Do przemysłu spożywczego



Złączki skręcane z mosiądzu niklowanego



Złączki skręcane z tworzywa POM



Łączniki samozaciskowe



Złączki mosiężne do rur miedzianych



Złączki do węży PVC



Adaptery



Pierścienie zaciskowe



Tulejki wzmacniające

Armatura gwintowana



Nyple



Mufy



Kolana



Trójniki



Korki



Przedłużki



Tłumiki hałasu



Śrubunki

Armatura gwintowana



Czwórniki



Redukcje



Złączki grodziowe



Listwy, kolektory

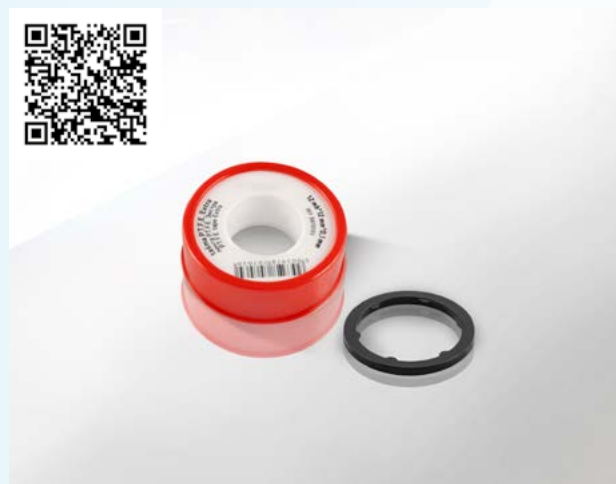

Taśmy, podkładki



Armatura nierdzewna



PRZEWODY I WĘŻE



Przewody i węże



Do złączy wtykowych
(kalibrowane)



Do złączy skręcanych
(niekalibrowane)



Przewody spiralne



Węże i przewody PVC



Węże teflonowe
wysokotemperaturowe



Węże do form
wtryskowych

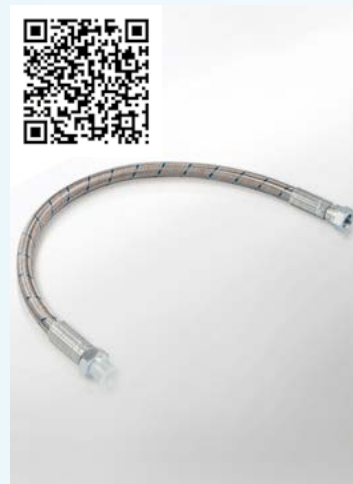

W oplocie stalowym



Akcesoria do
przewodów



Zwijacze

Zawory funkcyjne



Dławiąco - zwrotne wtykowe z tworzywa



Dławiąco - zwrotne kątowe mosiężne



Dławiąco - zwrotne aluminiowe



Szybkiego spustu



Logiczne

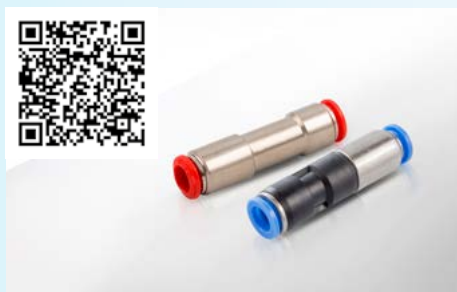

Zwrotne liniowe wtykowe



Zwrotne liniowe z gwintem



Zwrotne z filtrem



Dławiące aluminiowe



Zwrotne i odcinające sterowane



ARMATURA PRZEMYSŁOWA



Zawory kulowe i armatura



Kulowe standardowe (GW)



Kulowe standardowe (GW/GZ)



Kulowe z blokadą / odpowietrzeniem



Kulowe nierdzewne



Trójdrożne T/L



Kulowe mini



Do gazu



Wysokociśnieniowe



Odcinające liniowe

Elektrozawory membranowe / Odcinające



Membranowe 2/2 do wody i powietrza



Odcinające



SZYBKOZŁĄCZA I ZŁĄCZA DO WĘŻY



Szybkozłącza



DN 7,2



DN 10



DN 7,8



DN 5



DN 2,7



Złącza kłowe GEKA



Szybkozłączki CEJN
NW 10



Szybkozłączki CEJN
NW 7,6



NARZĘDZIA / POMIAR / BEZPIECZEŃSTWO



Manometr do pneumatyki



Manometry do reduktorów

Narzędzia pneumatyczne



Pistolety pneumatyczne

Zawory bezpieczeństwa



Manometry przemysłowe



Dysze



HYDRAULIKA SIŁOWA



Hydraulika siłowa



Cylindry dwustronnego działania z uchem dna



Cylindry dwustronnego działania z kołnierzem



Cylindry dwustronnego działania z jarmem



Cylindry dwustronnego działania z łapami



Cylindry z dwustronnym tłoczyskiem



Cylindry jednostronnego działania (nurnikowe)



Mocowania i osprzęt



KOMPRESORY I UZDATNIANIE POWIETRZA



Kompresory / Osuszacze / Filtry / Osprzęt



Śrubowe z osuszaczem



Śrubowe



Tłokowe



Tłokowe bezolejowe



Osuszacze



Filtry przemysłowe



Osprzęt



Wkłady filtracyjne



Centrum Producyjne Pneumatyki „PREMA” Spółka Akcyjna
Ul. Wapiennikowa 90
25-101 Kielce

Informacja o zamówieniach
+48 41 366 95 22
+48 41 366 95 21
sklep@cpp-prema.pl

Masz pytania?
Skontaktuj się z nami: